



# M.T.H. HO 4-6-4 Empire State Express Steam Engine

(PS3)  
ENGINEER'S GUIDE

Congratulations! You've just purchased the most feature rich and technically advanced HO steam engine ever produced! In addition, it happens to be produced by MTH, the leader in digital sound and control technology for model railroading. There will be many more engines to follow.

We hope you will enjoy them.

Now, let's get started.....



Passenger Station Announcement

**PLEASE READ THE MANUAL BEFORE USE AND SAVE**  
[WWW.MTHHOTRAINS.COM](http://WWW.MTHHOTRAINS.COM)

# TABLE OF CONTENTS

<b>UNPACKING YOUR ENGINE</b>	<b>4</b>
Removing and Unwrapping Your Engine	4
What Else is in the Box?	4
<b>PRODUCT OVERVIEW</b>	<b>5</b>
Getting to Know Your Engine	5
Engine Diagram	7
<b>SET-UP</b>	<b>8</b>
Coupler Installation	8
Engine and Tender Connection	9
Smoke Unit Preparation and Use	9
Removal/Installation of Drive Wheel Sets	9
Lubrication	12
<b>FEATURES AND OPERATION</b>	<b>13</b>
Analog DC (standard DC power pack)	15
DCC Digital Command Control	20
DCS Digital Command System	23
<b>SPECIFICATIONS</b>	<b>25</b>
<b>CARE AND MAINTENANCE</b>	<b>26</b>
Troubleshooting Guide	26
<b>SERVICE &amp; WARRANTY INFORMATION</b>	<b>32</b>
Service & Warranty Information	32
Limited One-Year Warranty	32

**CAUTION: ELECTRICALLY OPERATED PRODUCT:**

Recommended for Ages 14 and up. Not recommended for children under 14 years of age without adult supervision. As with all electric products, precautions should be observed during handling and use to prevent electric shock.

**WARNING:** When using electrical products, basic safety precautions should be observed, including the following: Read this manual thoroughly before using this device.

- M.T.H. recommends that all users and persons supervising use examine the hobby transformer and other electronic equipment periodically for conditions that may result in the risk of fire, electric shock, or injury to persons, such as damage to the primary cord, plug blades, housing, output jacks or other parts. In the event such conditions exist, the train set should not be used until properly repaired.
- Do not operate your layout unattended. Obstructed accessories or stalled trains may overheat, resulting in damage to your layout.
- This train set is intended for indoor use. Do not use if water is present. Serious injury or fatality may result.
- Do not operate the hobby transformer with damaged cord, plug, switches, buttons or case.

This product may be protected by one or more of the following patents: 6,019,289; 6,280,278; 6,281,606; 6,291,263; 6,457,681; 6,491,263; 6,604,641; 6,619,594; 6,624,537; 6,655,640.

# QUICK START GUIDE

Of course, you should read your manual over before running your M.T.H. HO Steam Engine. But if you just can't wait, choose how you want to run below and enjoy!! Now, after a few minutes, shut her down and read through your engineer's guide.

## I USE A REGULAR DC SUPPLY...

Step 1: Unpack your Engine and Tender. (refer to unpacking instruction on pg 4)...

Step 2: Set the engine on the track ...

Step 3: Apply increasing **DC** voltage until she starts up and pulls out!

## I'M A DCC OPERATOR....

Step 1: Unpack your Engine and Tender. (refer to unpacking instructions on pg 4)...

Step 2: Set the engine on the track ...

Step 3: Power up your DCC system...

Step 4: Select engine address 3 and press "F3" to start her up...

Step 5: Turn the throttle and head on down the pike...

## I RUN DCS....

Step 1: Unpack your Engine and Tender. (refer to unpacking instructions on pg 4)...

Step 2: Set the engine on the track ...

Step 3: Power up your DCS system...

Step 4: Add the engine to your system and start her up...

Step 5: Turn the throttle and move out....

**CAUTION:** M.T.H. HO engines ***DO NOT OPERATE ON AC VOLTAGE.***

Applying AC power to your locomotive could cause permanent damage and will void your warranty.

# UNPACKING YOUR ENGINE

## Removing and Unwrapping Your Engine

---

Carefully remove and unwrap the model on a soft surface. By nature, models with high levels of detail have some small fragile parts.

Carefully remove any foam packing pieces that may be surrounding the model.

### What Else is in the Box?

The following items are packed with your engine.

#### Engineer's Guide (1)

You probably know that since you're reading it.

#### Smoke Fluid Pipette (1)

Enough fluid to get you started and then some.



#### Drive Wheel Set without Traction Tires (1)

For Those who prefer not to use traction tires.



#### 3mm Nut Driver (1)

In case you want to install the drivers without traction tires or replace the standard drive wheels.



#### Couplers (2) with mounting hardware



Tender Coupler



Engine Coupler

# PRODUCT OVERVIEW

## Getting to Know Your M.T.H. HO Locomotive

### Key Features

---

Your new HO Steam Engine is equipped with the exclusive M.T.H. Proto-Sound® 3.0 digital sound and control system. In plain English, this means your locomotive contains state-of-the-art electronics providing realistic digital sounds, puffing smoke perfectly synchronized with chuffing sounds and motion, precisely controlled speed in increments of 1 scale mile per hour, and much, much, more.

### Compatibility

---

The Proto-Sound 3 system is universally compatible with track power and/or signal combinations including analog DC (regular DC power pack), DCC (NMRA Digital Command Control), or DCS (MTH Digital Command System). Simply set your Engine on the rails, apply any one of these power/signal sources, and move out! The Proto-Sound 3.0 system automatically senses the track environment and adapts accordingly. No hidden jumpers, switches, magic wands, or programming required!!! A vast array of realistic operation is automatic when the Engine is run on analog DC. You can expand access to features in a DCC environment. Experience the most your new locomotive has to offer in the simple to use yet powerful world of DCS. **To be clear, DCS is NOT a proprietary version of DCC, as some other manufacturers offer. DCS is a comprehensive layout control system designed with one primary goal: make model trains do amazingly realistic things using a simple and intuitive controller. We put the complexity on the inside, and the fun in your hands!**

### Digital Sound

---

Your Proto-Sound 3 (PS 3) equipped Engine contains over 100 individual recordings. These recordings are played back dynamically at appropriate times to create a symphony of realism for your ears. Hear the chuffs automatically intensify or lighten when speeding up or slowing down, listen to the sounds of brakes squeaking and squealing as you come to a stop, or enjoy the random conversations of railmen working as your model sits at idle. It's all there and it's incredible.

Now, your HO Engine includes the ultimate in realism Proto-Whistle. With this incredible new feature you have variable control over the steam whistle sound in your locomotive (when operated in DCS mode with the DCS Commander or DCS software version 4.0 or greater). Also included is a one button push Grade Crossing Whistle

## Digital Control

---

In standard analog DC mode, your model still operates under digital control. The PS 3 advance speed control system converts track voltage into digital speed commands. Your model will run smoothly and consistently at any speed regardless of load, hills, or curves. If you are a DCC user, you'll quickly learn to appreciate the precision of our speed control and linear speed curve. DCS users will enjoy the added benefits of controlling speeds in increments of 1 scale mile per hour displayed on DCS controllers or easily changing acceleration and deceleration rates independently without any discussion of bits or bytes. **To be clear, DCS is NOT DCC.**

## Lights & Smoke

---

As you read on, you'll notice there are no instructions for replacing light bulbs in your Mohawk. That's because there aren't any. We use specially designed and controlled LEDs to create realistic lighting effects that occur automatically. Again, **NO PROGRAMMING!!** Just come to a stop and watch as the headlight dims automatically in accordance with rule 17. Of course, as you pull away, the headlight returns to it's fully bright, yet warm, glow. We even included a light in the cab so the engineer and fireman can see to do their jobs!

M.T.H. is renowned for our realistic smoke systems. This HO Steam Engine is no exception. When the smoke is on, you will experience copious puffs synchronized precisely with chuffing sounds at 4 times per revolution of the drive wheels. Of course, when you stop, the smoke wafts out of the stack steadily, just like the real thing! The smoke behavior applies to all operating modes, analog DC, DCC, or DCS. With some DCC controllers, you can turn smoke on and off remotely. In DCS mode, you can not only toggle smoke on and off with the press of single button, you can actually select from 3 output levels to keep those smoke alarms from going off!

## More...

---

In analog DC operation, just flip the track polarity or direction switch at any speed and watch your Engine gradually come to stop, turn on the appropriate directional lighting, and smoothly accelerate back up to speed. No other HO locomotive has features like these. There are so many more things to learn and enjoy about M.T.H. HO Engines, we could write a book. But, that's no fun. So, if you haven't already done so, flip to the Quick Start Guide and let's run your new engine!!

# ENGINE DIAGRAM

## Boiler

---

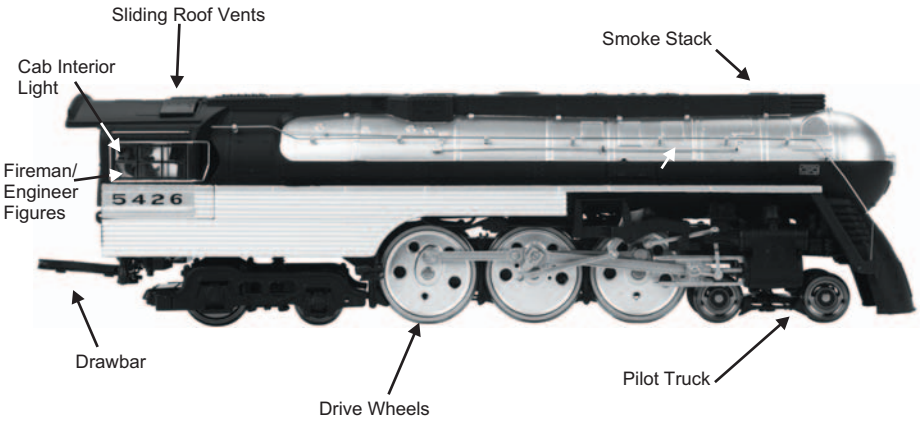

## Tender

---



# SET-UP

## Installing Couplers

The coupler for the tender is mounted on the rear of the tender using the Draft Gear Box that is supplied with the coupler hardware. The Draft Gear Box with the Coupler installed is attached to the tender by one screw. The lip of the Draft Gear Box Lid should be placed against the outside of the rear sill of the tender.



### To install the coupler on the tender:

- Place the tender upside down in a foam cradle or other soft surface. Make sure that the tender will not roll over.
- Place the coupler in the Draft Gear Box. When the Draft Gear Box is in a position so that the area covered with the Draft Gear Lid is facing up, the coupler should be placed in the Draft Gear Box with the Trip Pin hanging down.
- Carefully place the assembled Draft Gear Box and Coupler on the rear of the tender chassis and insert the larger screw supplied with the couplers to secure the Draft Gear Box.

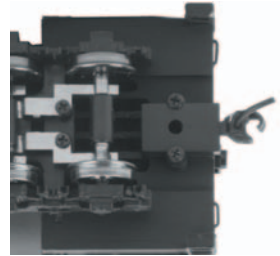

**Engine Pilot:** The pilot coupler supplied in the packaging is an HO scale coupler. Prior to mounting the coupler to the engine, the coupler must be inserted into the draft gear. The draft gear and coupler is then inserted into pilot and attached with a single screw that is supplied in the packaging.

### To install the coupler for the engine:

- Place the engine upside down in a foam cradle or other soft surface. Make sure that the engine will not roll over. Be careful of the small details on the boiler.
- Remove the center section of the pilot by pushing on it from the backside. Then insert the coupler into the draft box and inset the draft box with couple through the hole in the pilot and secure it with a screw that is supplied in the packaging.
- Insert the coupler into the slot in the pilot.
- Align the hole in the draft box with the tapped hole on the underside of the pilot and attach the draft box using the mounting screw that is supplied in the packaging.

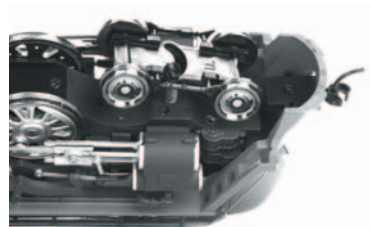

*Reference photo only*



## SET-UP

### Connection of the Engine and Tender

---

Your M.T.H. HO Steam Engine is equipped with bus type draw bar. The drawbar not only connects the engine and tender it uses two electrical conductors to transmit digital information between the engine and the tender. Connecting the engine and the tender is just a matter of inserting the drawbar pin on the front of the tender into the hole closest to the engine is for operation on smaller radius curves (less than 44 inch radius). The hole at the end of the drawbar is for larger radius curves (44 inch radius or greater).



### Smoke Unit Preparation and Use

---

Your M.T.H. HO Steam Engine is equipped with a proven fan-driven smoke system design featured in M.T.H. products for over 10 years. The performance and realism of this system is unparalleled in the model train industry.

Your smoke unit comes primed from the factory however, before running the smoke unit for more than a few minutes, you should add more fluid. Add between 10-15 drops initially and whenever smoke output diminishes or if the engine has been stored for a long period of time. We provided some fluid with your model to get you started. Versions with twin smokestack openings should have smoke fluid applied in the forward smokestack opening only.

The smoke unit is controlled differently depending upon how you run your engine so, for particulars on turning it on or off or setting the output levels, check out the features and operation section.

You shouldn't run your smoke unit without fluid. Doing so can cause overheating and reduce the performance and/or life of the unit. If you wish to operate your engine without smoke, turn the smoke unit off. Do not let the smoke unit go dry with the smoke unit turned on. Of course, we recommend using only M.T.H. ProtoSmoke fluid. Super Smoke and LVTS brands also work fine.

### Removal/Installation of Drive Wheel Sets

---

Your M.T.H. HO Steamer comes from the factory with a set of traction tire equipped drive wheels installed and an alternate set without traction tires available separately in the box. The traction tires provide exceptional pulling power on grades and through curves but should you prefer the traditional appearance of steel drive wheels, the alternate set can be easily installed by following the steps on the next page.

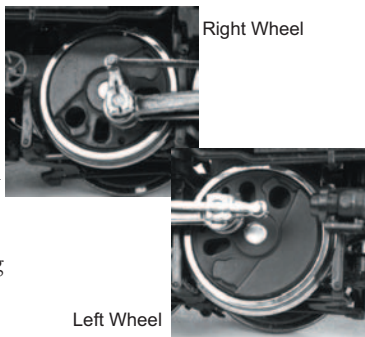

First, position the engine upside down in a foam cradle or other soft surface, while being careful of the small details on the boiler. Using a small flat blade screwdriver, carefully remove the drive rod screws (2) on the 3rd set of drive wheels. There's one on each side.

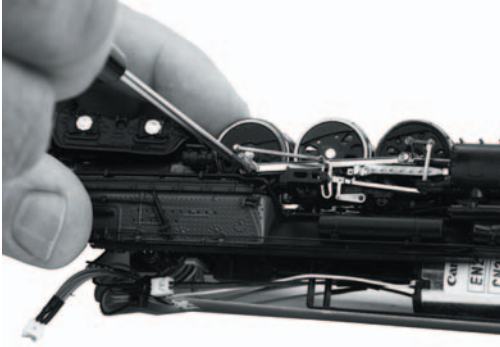

**MAKE NOTE OF THE ECCENTRIC CRANKS IN REACTION TO THE AXLE IF THE DRIVER BEING CHANGED. THE ECCENTRICS MUST BE RE-ASSEMBLED IN THE SAME POSITION.**

Remove the Brakeshoe detail along with the bottom plate by removing the 4 screws indicated in the picture below. Set the cover aside and don't do anything further until you have completely read the Caution Note.

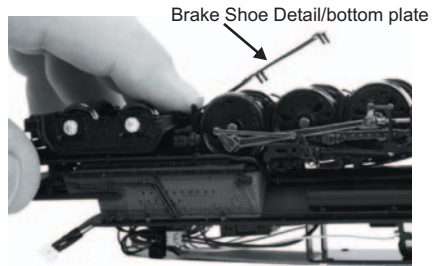
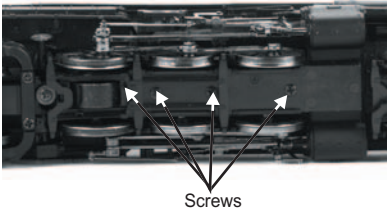

### Caution Note

Before proceeding, there are a couple of important things to know. First, under the square bushings on each end of the axle are tiny springs. They are critical to the proper operation of your engine and you don't want to drop them. Next, look closely at the wheel set and bushings and take note of their orientation..

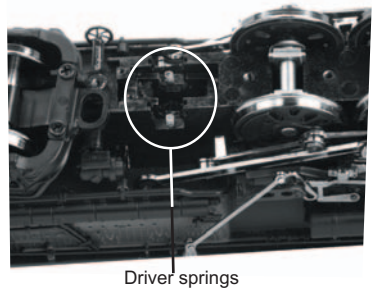

Now, remove the two screws holding the gearbox cover in place. Then carefully remove the gearbox cover and set it aside.

Next very slowly and carefully lift the wheel set upward. Keep a close eye out for the driver springs as they sometimes stick to the bushings and lift out. If you drop one, you'll need some really good eyes or a magnet to find them. If they should lift out with the wheel set, carefully set them back into cavities from which they came.

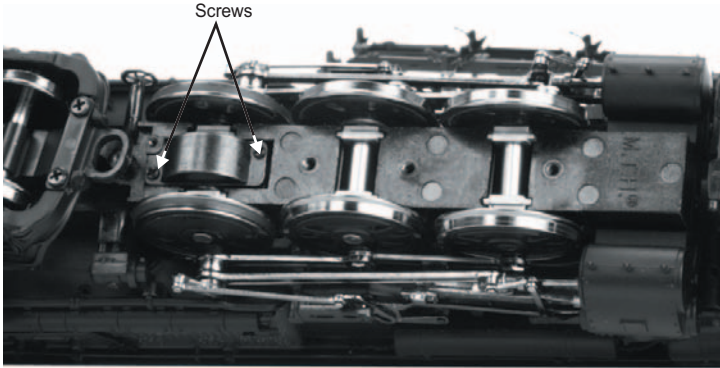

Drop the replacement wheel set into the chassis. Make sure the bushings are in the correct orientation. The small rectangular tabs on the front and rear must be upward (with the engine upside down) toward the chassis bottom cover. The smooth side faces the springs

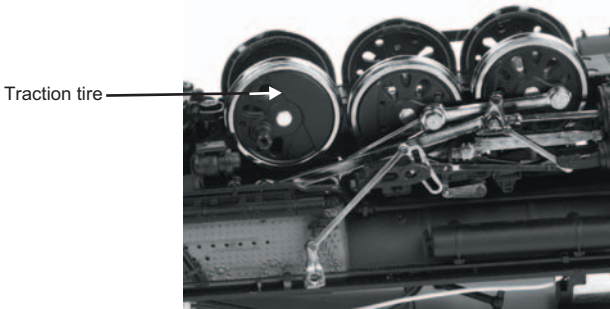

## Reinstall Gear Box Cover

Reinstall the chassis bottom cover with 5 screws and install the drive rod screws. See, you've done it.

# Lubrication

---

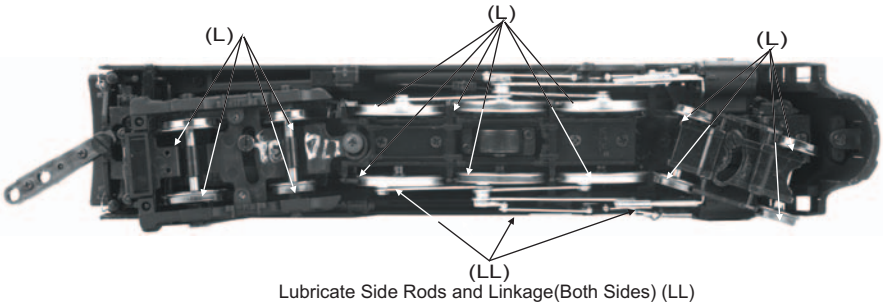

Using light machine or household oil, apply a very small amount to all drive rods, linkages, axles, and other moving parts as shown.

Your gearbox is properly greased at the factory and probably never needs service however, if you run excessive hours pulling heavy loads, it's a good idea to remove the 2 screws from the gearbox cover and re-grease using M.T.H. gear grease or equivalent.

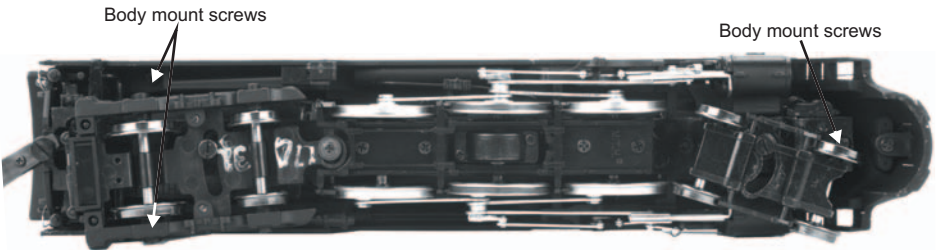
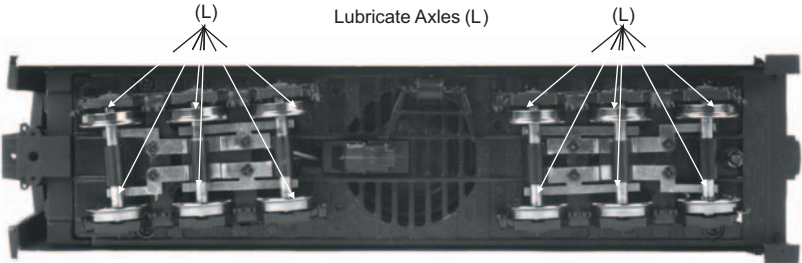

# FEATURES AND OPERATION

Now, for the fun stuff! Your new M.T.H. HO Steam Engine has more features and operating capabilities than any HO engine ever built by any manufacturer. We're going to walk you through everything she does in general but, you'll probably find a few we forgot to mention on your own.

## Modes of Operation

---

There are 3 modes of operation with different levels of features accessible in each. We refer to them as analog DC, DCC, and DCS. Here's a little more explanation before we get into the features of each mode.

### Analog DC

This is when there is nothing connected to the rails except a conventional DC power pack. These power packs generally have at least one variable output controlled by a throttle of some sort and a means of reversing DC polarity on the track to change the direction of your engine.

### DCC or Digital Command Control

DCC is a popular digital command control scheme wherein the track power is also a digital control signal. That is, using a DCC controller, you can communicate with multiple engines and have them all moving at different speeds or moving in opposite directions on the same track at the same time. The power/command signal remains constant and engines are “commanded” to perform as desired. M.T.H. is new to DCC but, we recognize it's importance to many HO operators. So, we loaded our engine with more DCC features easily accessible to the operator than any HO engine ever built previously. You DCC guys are in for a real treat!

# FEATURES AND OPERATION

## DCS or Digital Control System

While the acronyms are close, this is about where the similarities between DCS and DCC end. Yes, they are both digital control systems however, M.T.H. DCS is NOT DCC. There are several proprietary versions of DCC on the market but friend, this is NOT one of them. M.T.H.'s DCS system is proven technology in the O and One gauge markets and now, we've brought its power and simplicity it to you.

First, the power signal in DCS is NOT the command signal. Next, DCS employs a fully functional bi-directional communication scheme opening a vast range of advanced features and yet, is so simple and intuitive, you can enjoy them! No programming tracks, bits and bytes, or conversion of binary to hexadecimal numbers here! To add an engine in DCS, just press "ADD ENGINE." After that, If you want to start your engine, just press "START UP" or, to turn the smoke on or off, just press "SMOKE." No combinations of letters or numbers to remember! We think you're really going to like this!

# Analog DC

---

Not much explanation is required here, and that's exactly why you run your trains this way! Here's the good news, even if you like to keep it simple, your MTH HO engine is packed with cool sounds, sights, and smells yes, smells, that you're going to love.

## Running the Engine

Set the engine on the rails, and apply DC power. Refer to the Set-Up section of this guide for instructions on how to connect the boiler and tender.

As you increase power, at about 6 volts, the lights and sounds will come on. If you continue to increase power, and the smoke switch is on, the smoke unit will kick in at about 7 volts. More on the smoke further down. Keep going on up to about 8 and she'll move out! About 16 volts DC is adequate for prototypical speeds however, your engine can handle up to 24 volts DC if you feel the need for speed!

## Changing Direction

If you flip the direction (polarity) switch on your power pack while the engine is moving, it will gradually slow to a stop, and slowly accelerate back up to speed in the opposite direction. This is an exclusive feature of MTH engines that we're sure you'll enjoy. You can also change direction the old fashioned way by reducing throttle until the engine stops, flip the direction switch, and then increase throttle again. Either way is OK, we just thought a graceful transition from any speed would be cool.

If you switch track polarity too slowly, the engine may stop abruptly and not move in the reverse direction. This is normal. There is a feature we call “anti-jack rabbit” that prevents the engine from taking off at high speeds when high voltage is applied to the track instantly. Some direction switches have a “dead” spot where the power is completely off during polarity changes. This can invoke the anti-jack rabbit feature. The solution is to flip the direction switch more quickly. Don't worry you won't hurt the engine.

## Speed Control

Your engine is equipped with speed control. This feature is always active, even in analog DC mode. Basically, your engine constantly measures track voltage and converts this to a digital speed command. You should notice the speed remains constant up and down grades, around curves, and with varying loads. This is no accident. You've got the most precise speed control system available today.

## Sounds

In this mode, sound are pretty much automatic. If you're moving, you'll hear chuffing sounds. If you increase or decrease the throttle quickly, you'll hear labored or drift chuffing, respectively. Of course, if the engine has been sitting for a while, the engineer may open the steam cocks and release the moisture, don't worry, he never forgets to close them.

When your sitting at idle, there may be some maintenance done. You could hear someone dopping the siderods or checking the water level in the tender and filling it if necessary. Don't worry, all of this and more is just a normal part of everyday operations.

When your moving at a pretty good clip and you reduce the throttle quickly, you may hear the brakes squeak and squeal as the engineer applies them. Of course, they'll stop when the engine does.

If things get too noisy, just locate the sound volume pot under the water hatch on the tender and adjust the volume from maximum down to off, whatever suits you. Turn it counterclockwise to reduce the volume or clockwise to increase it.

## Smoke

Running your smoke unit couldn't be simpler. There is a switch hidden under the water hatch on the tender. If this switch is on, your smoke is on. If it is off, your smoke is off

When you turn the smoke on, just give it a few seconds to warm up. It doesn't start instantly. Once you see smoke gently streaming out (or not if you prefer) snap the water hatch detail back in place and away you go.

Once on, like the sounds, the behavior is fully automatic. The model will puff out smoke in exact synchronization with the chuffing sounds and driver rotation at 4 per revolution. Amazing!

When the output begins to diminish significantly, add 10-12 drops to recharge the unit. Again, give it a few seconds to warm back up. The cool fluid slows the action for a few seconds. Also, watch out for bubbles that may block the stack. You may need to gently blow down the stack to clear it.

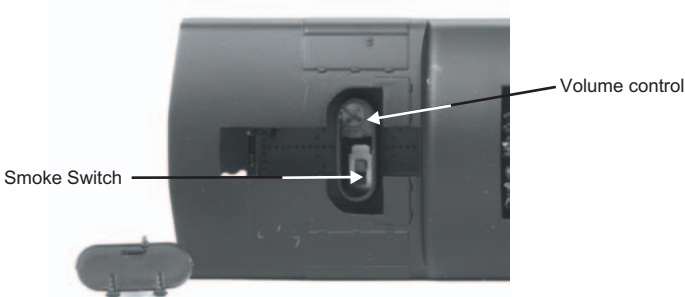



## Lighting

Now, this is an illuminating section (we couldn't resist). Your model is equipped with a headlight, marker lights, cab interior light, and classification lights.

The first thing to know about the lighting is there aren't any bulbs. It's all LEDs so, if you look for a section on how to replace them, you won't find it. You should never have to.

As with sounds and smoke, in analog DC mode, lighting operation is fully automatic. They're always on and behave appropriately.

The headlight functions under rule 17 and dims when stopped for a time or while backing up. Of course, just as you begin to move forward, it goes bright to show the way.

The cab light is always on so the engineer and fireman can always see clearly!

## DCC Digital Command Control

---

Now, if your operating in this mode, you may very well know more about DCC than we do so, we're going to stick to telling you about our engine in this operating environment. First of all, in DCC mode, we brought all the features of analog DC along and of course, added to them. Your new engine has more user features than any DCC engine ever built. Some of them are even ahead of the world of DCC!!

## Running the Engine

Set the engine on the rails, and apply DCC power. Refer to the Set-Up section of this guide for instructions on how to connect the boiler and tender.

The first thing you will notice is the engine does absolutely nothing! Don't panic. This is by design. M.T.H. HO engines never do anything in command mode until told to do so, regardless of what brand DCC controller you use. In this way, you could have a fleet of M.T.H. HO engines on the rails and they will remain shutdown until you command them to start up.

## F3 Start up/Shut Down

Select engine address 3 (factory default), press the F3 (Start Up/Shut Down) key, and your engine will start-up. Lights, sounds, smoke, ACTION!!! Roll the throttle and away you go. Our models are compatible with 14, 28, and 128 speed steps. We strongly recommend 128 because in this mode, speed steps correspond directly to scale speeds. That is, speed step 10 = 10 smph, speed step 47 = 47 smph, etc. You get the idea. When your done, press the F3 key again, your engine will shut down.

To be clear, pressing F3 when the engine is shut down will start it up. Pressing F3 when the engine is started up will shut it down. Pretty clever, eh?

## Sounds

As in analog DC mode, the default sound arrangement is automatic. So, you can just run your engine and its sounds will follow the action. But, you operate in DCC for a reason. You want access to more features, right? Well, depending upon the capabilities of your DCC controller, you now have access to a range of sound features including bell, whistle, PFA, engine sounds on/off, master volume, Doppler, and more.

Here's a brief description of commonly used sound features.

### **F1 Bell**

Toggles bell sounds on/off. Listen to the last half ring of the bell when it stops!

### **F2 Whistle**

Blows the whistle for as long as it's on. There are several different ending signatures depending on how long you hold the button down. Check it out!

### **F4 PFA**

PFA in MTH lingo stands for passenger and freight announcements. Since your engine provides freight service, you'll hear freight yard sounds.. PFA is a very popular sound feature that's a staple in almost all MTH products. We had to give you this!

There are 4 sound sequences or segments in PFA. You advance through them at your command. Each segment has a minimum time of ~10 seconds but more sounds play the longer you listen.

When running the engine, simply press the F4 key to activate PFA. When you bring the engine to a stop, the arrival sequence will play. You can remain in this segment as long as you like.

Press F4 again, and advance to disembarking sequence. Again, you can listen to this sequence as long as you like.

Press F4 again, and advance to the embarking sequence. Again, you can listen to this sequence as long as you like.

Press F4 again, and advance to the departure sequence. After the engineer says "Just keep the steam up" and the engine will automatically pull out and resume the speed and direction of when you entered the feature. The bell will ring for a short while and then turn off automatically.

### **F6 Engine Sounds**

Toggles engine sounds on/off. Think of this like a mute button. When the engine sounds are off, you can still ring the bell or blow the whistle or run the engine, it just helps if you have to answer the phone.

## F7 Master Volume

This command cycles through 9 volume settings from off to max. Each press advances to the next cycle. Unlike the F6 engine sounds command, when the master volume is set to off, no sounds can be heard.

If your DCC controller has more F functions, you can access even more features. Check out the complete list in the chart at the end of this section.

## Smoke

The smoke system in DCC mode operates exactly as it does in analog DC mode with the added benefit of being able to turn it on or off remotely. Pressing F8 on your DCC controller will toggle the smoke unit on and off again.

The manual smoke switch under the water hatch on the tender must be “on” for the F8 key to function. When the smoke switch is off in DCC mode, the smoke is always off.

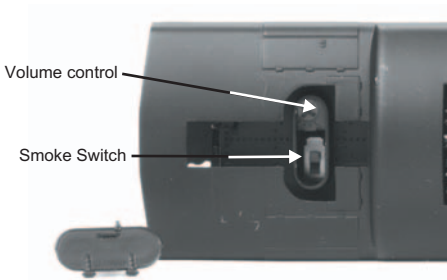

In the future, as DCC controllers expand to include more functions, you'll be able to cycle through low, medium, and high output settings in DCC. Refer to the DCC function chart for details.

## Lighting

As with other feature categories, lighting in DCC mode operates just like analog DC with regard to rule 17, constant brightness and directional behavior. See that section for details. DCC provides some additional control to suit your preferences.

### F0 Headlight

Toggles the headlight on/off.

### F5 Cab Interior Light

Toggles all lighting on/off, including Marker and Classification LED's. When on, all lighting behaves automatically as described elsewhere. When F5 is off, all lighting is off.

## More DCC

Okay, we've walked you through the basic features and functions available in DCC (F0..F8) but, there is much, much more. In fact, we've filled up functions F9 through F28. Some controllers are available today that provide easy access to F9 through F12 however, we don't know of any that allow you to press a button for F13 through F28. When the DCC controllers expand to include these functions, your MTH HO engine will be waiting. Here is a list of the F9 through F28 functions present in your engine with a brief description of how they work.

### **F9 Forward Signal Sound**

Plays 2 short whistle toots to signal the engine is moving forward

### **F10 Reverse Signal Sound**

Plays 3 short whistle toots to signal the engine is moving in reverse

### **F11 Coupler Slack Sound**

When sitting still, arms the system to play the sound of coupler slack being pulled out as the engine moves.

### **F12 Grade Crossing Whistle**

One button push will blow the whistle for 1 long, 1 short, and 2 longs to signal for a grade crossing.

### **F13 Doppler**

Activate one shot doppler

### **F14 Extended Start UP**

Plays a longer, more detailed and realistic start up sound sequence.

### **F15 Extended Shut Down**

Plays a longer, more detailed and realistic shut down sound sequence.

### **F16 Labor Chuff**

Plays deeper and sharper chuffing sounds to simulate a heavy load

### **F17 Drift Chuff**

Plays softer and lighter chuffing sounds to simulate a light load

### **F18 Smoke Volume**

Cycles smoke volume through min, med, and max output levels.

### **F19 Whistle Toot**

Plays a single short whistle toot so you can make up your own signal patterns.

### **F20 Coupler Close**

Plays the sound of 2 couplers crashing together and closing.

**F21 Feature Reset**

Resets the engine back to factory defaults with the exception of the address.

**F22..F25 Idle Sounds 1 - 4.**

Plays what we call idle recipes 1 through 4. These sound sequences play randomly when the engine is at idle but if you have these F functions, you can trigger them whenever you like.

**F26 Brake Sounds**

Toggles brake sounds between auto and off. They are on by default but you can turn them off.

**F27 Cab Chatter**

Toggles random voices between auto and off. They are on by default but you can turn them off.

**F28 Clickety-Clack**

Toggles the sounds of sustained speed inside a passenger train between auto and off. This sound is off by default but you can turn it on (auto). Once on, if you maintain a steady speed of ~30 smph or higher for more than 30 seconds, the effect automatically turns on.

## DCC "F" FUNCTION LIST

<u>F Key</u>	<u>Function</u>
F0	Headlight on/off
F1	Bell on/off
F2	Whistle/Horn on/off
F3	Start-up/Shut-down
F4	PFA initiate and advance
F5	All Lighting on/off Cab Lighting
F6	Engine Sounds on/off
F7	Volume low, med, high, off
F8	Smoke on/off
F9	Forward Signal Sound
F10	Reverse Signal Sound
F11	Coupler Slack Sound
F12	Grade Crossing
F13	Doppler
F14	Extended Start Up
F15	Extended Shut Down
F16	Labor Chuff
F17	Drift Chuff
F18	Smoke Volume low, med, high
F19	Single short whistle toot
F20	Coupler Close
F21	Feature Reset
F22	Idle Sequence 1
F23	Idle Sequence 2
F24	Idle Sequence 3
F25	Idle Sequence 4
F26	Brakes auto/off
F27	Cab Chatter auto/off
F28	Clickety-Clack auto/off

### **CV Description** (Program On Main, POM Only)

1	Short Address 1-127
3	Acceleration Rate 1-25 smph / sec (4 smph / sec is the default)
4	Deceleration Rate 1-25 smph / sec (4 smph / sec is the default)
17 & 18	Extended Address (upper bits must be set to 1)
29	Enter 38 to set extended address to engine cab number or Bits 5 = ext.addr; bit 1 = speed / direction method
49	Short Address (controllers that prohibit addr POM)
50 & 51	Extended Address (controllers that prohibit addr POM)
55	Reset - Sends value = 55 to CV55 on address 55 (Do not assign address 55 to any engine as an engine address)

# DCS Digital Control System

---

As you may have gathered by now, DCS is an M.T.H. exclusive Digital Control System that provides easy access to dozens and dozens of features in our models. We developed DCS to provide a powerful and advanced model train control system that was simple and enjoyable to use. We've accomplished that goal. DCS further expands the features available far beyond that of DCC. After all, in DCC, we only had a limited number of “F” commands to fill.

As with DCC, we'll leave the detailed “how-to” system explanations to the DCS system manuals. What you should know are all the cool features your engine has built-in, waiting for you to experience.

## Running the Engine

In DCS, you simply place your engine on the rails, press “ADD ENG” and the system will scan the track and automatically upload your engine into the controller. At this point, you can press “START UP”, roll the throttle and pull out! That's it!

## Speed Control

DCS engines are controlled in scale miles per hour (smph) and increments of one. So, that means if you dial up 10, your engine will smoothly accelerate to 10 smph. There is no need to select a speed step setting, there's only one precise linear control at scale speeds. See, powerful yet simple.

## Sounds

Introducing the ultimate in prototypical operation Proto-Whistle. Your new M.T.H. HO Steam Engine includes this amazing feature. It allows you to adjust the pitch of the steam whistle just like you were sitting the cab pulling the whistle rope yourself. This new feature is controllable from either your DCS Commander or with your DCS system with software version 4.0 or greater (see your DCS or DCS Commander instruction manual for specifics on how to operate this feature)

Not only that but your M.T.H. HO Steam Engine also has a Grade Crossing Whistle Feature. To trigger the Grade Crossing Whistle press the A3 button on your DCS Commander or the SXS softkey on your DCS Remote Handheld.

## Independent Volume Settings

Using DCS, you independently adjust the bell, whistle, engine, and accent sounds volume. This is like a mixer so you can set up the engine fit your specific tastes and sense of realism. Oh, they all move relatively up or down with the master volume settings.

## Sounds

### Chuff Rate

You can adjust the chuff rate from the default setting of 4 per revolution to whatever you like between 1 and 16 per rev. Why? Some folks like to run fast and 2 or 3 chuffs per rev keeps chuffing sounds a little more distinct, even though it isn't prototypical.

### Doppler Loop

You can either press the Doppler button on the remote to activate what we refer to as “one-shot” Doppler or, using DCS, you can program a Doppler loop that will peak at the same point on your layout, over and over.

### Custom Sounds

You can fire any of 10 individual sound bites pre-loaded into your engine. These are typically, blow downs, steam let-offs, etc., etc. Each one at the press of a single button. You can also make voice or other audio recordings and play them back on command with ease.

### Proto-Dispatch

Press the “MIC” (microphone) button on your DCS remote and speak. Your voice will be digitized and played out of the model in real-time. Talk about station announcements!

### Proto-Cast

Another MTH exclusive, you can connect any audio source with a line output to the DCS TIU and send music, train sounds, or anything you like down the rails to be played through the engine as it moves along the track. Your holidays may never be the same!

### Smoke

In addition to a simple button labeled, go figure, “SMOKE” to toggle your smoke on and off, you get the ability to quickly and easily adjust the output volume. In plain English, you simply select low, med, or hi.

### Lighting

As with everything in DCS, this becomes a little more than obvious. Pressing the “HEADLIGHT” button turns off the directional headlight and reverse light (if equipped). Pressing the Interior light will turn off the cab interior light.



# SPECIFICATIONS

Electrical	Input Voltage	0 - 24 VDC
	Current Draw (w/smoke, lights, sounds)	~230 – 650 mA
	Lighting	LED - Rule 17
	Fan Driven Smoke	Yes
Operating Modes	Analog DC	Yes
	DCC - Digital Command Control	Yes
	DCS - Digital Control System	Yes
Default Addresses	DCS	1
	DCC short	3
	DCC extended	Cab No. or 3333

## US PATENTS

US 6,457,681      Oct. 2, 2002  
US 6,619,594      Sept. 16, 2003  
US 6,655,640      Dec. 2, 2003

©2009, M.T.H. Electric Trains  
Columbia, MD 21046

# CARE AND MAINTENANCE

## HO Troubleshooting Guide

The following Guide will help you trouble shoot your M.T.H. HO engine. This guide is broken up into the three operating modes of the engine Analog DC, DCC, and DCS

### Analog DC

<b>Start-up</b>	<b>Solution</b>
When I apply power to the track my engine doesn't do anything. No lights, no sound, no nothing.	Check to see if that section of track has power. Use a voltmeter or a lit passenger car.
	Slide the engine a couple of feet in either direction, you may have a bad track section
	Have you got that section electrically isolated with a toggle switch or other device?
<b>Sound</b>	<b>Solution</b>
I have no sound from my engine, but my lights are on and it moves just fine.	Check the volume pot on your tender. Full CW = Max volume
There's a crackling sound from my tender	Check to see if a screw or some other material hasn't lodged itself in the underside of the tender.
<b>Smoke</b>	<b>Solution</b>
My engine isn't smoking at all	Make sure you've got the smoke switch ON
	If you just filled it with smoke fluid sometimes the fluid can make a seal in the stack. Blow down the stack to clear the air bubble
	Check the Tender/Boiler drawbar connection. You've got to have them locked together
My engine's smoke output is low	If you've been running your engine in DCS or DCC mode the smoke may have gotten set to Low or Med. With the engine running in DCS or DCC set the smoke back to Hgh. It'll remember what you last set it as when you run it again in Conventional DC
	Check for an obstruction in the smoke stack
	Add 10-12 drops of smoke fluid

<b>Lights</b>	<b>Solution</b>
One of my lights is out	Most likely you had been running the engine in DCC or DCS mode and toggled that light off. Put it back into one of those modes and turn that light back on. The engine will remember that when you run it again in Conventional DC.
None of my lights are on	Could be the same reason as “One of my lights is out”
	Is the engine getting power? Check to see if there is voltage on the track or move the engine a few feet in either direction.
	Check the Tender/Boiler drawbar connection. You’ve got to have them locked together.
<b>Motion</b>	<b>Solution</b>
When I apply power to the track my engine starts up (lights and sound) but it won’t move	Lower the track voltage then raise it again. The engine should start moving. If you apply greater than 9VDC quickly the engine will just set there. Lowering it below 9VDC then raising it will get the engine moving
	Check the Tender/Boiler drawbar connection. You’ve got to have them locked together.
My engine hesitates at slow speeds	An engine may do this right out of the box if it has not been lubricated. Follow the lubrication instructions. Now go ahead and run it.
	New engines even after they are lubricated may take a little bit to get everything run in. Be a little patient and let it run for a bit. It should clear up shortly after lubricating and running
	Check to see if you have any kind of binding on the side rods. There may be a chunk of your favorite, perfectly scaled pine tree stuck in there.

## DCC

<b>Start-up</b>	<b>Solution</b>
When I apply power to the track my engine doesn't do anything. No lights, no sound, no nothing.	Did you press F3 yet? F3 on your DCC handheld will start your engine up.
	Check to see if that section of track has power. Use a voltmeter or a lit passenger car, not your tongue.
	Slide the engine a couple of feet in either direction, you may have a bad track section
	Have you got that section electrically isolated with a toggle switch or other device?
<b>Sound</b>	<b>Solution</b>
I have no sound on my engine, but my lights are on and it moves just fine	You may have it turned off. Repeatedly press F7 to cycle through the volume levels (there are 9 levels, 0-max)
There's a crackling sound from my tender	Check to see if a screw or some other material hasn't lodged itself in the underside of the tender.
When I run Doppler I can hear the Doppler shift but then the engine sounds fade out and I can't get them back	This is normal. You will need to press the F12 button again to turn Doppler off. Your engine sounds will now return to normal
<b>Smoke</b>	<b>Solution</b>
My engine isn't smoking at all	Make sure you've got the smoke switch ON. It must be ON for the smoke to operate in DCC mode
	Press F8 on your DCC handheld. This will activate the smoke
	Check the Tender/Boiler drawbar connection. You've got to have them locked together
	If you just filled it with smoke fluid sometimes the fluid can make a seal in the stack blow down the stack to clear the air bubble.
My engine barely smokes	You may have set the smoke to Low. F17 will vary the smoke levels. Or, if you were running it in DCS mode you may have toggled it there (If you don't have F17 on your DCC handheld you will have to put it back into DCS mode and change it from there)

	Check for an obstruction in the smoke stack
	Add 10-12 drops of smoke fluid
<b>Lights</b>	<b>Solution</b>
One of my lights is out	Check your F keys. F0 is the headlight (also controls the Back-up light) and F5 will toggle the Cab light
None of my lights are on	Could be the same reason as "One of my lights is out"
	Is the engine getting power? Check to see if there is voltage on the track or move the engine a few feet in either direction.
	Check the Tender/Boiler drawbar connection. You've got to have them locked together.
<b>Motion</b>	<b>Solution</b>
When I apply power and hit F3 my engine powers up but it won't move	Check the Tender/Boiler drawbar connection. You've got to have them locked together.
My engine hesitates at slow speeds	An engine may do this right out of the box if it has not been lubricated. Follow the lubrication instructions. <b>Now go ahead and run it.</b>
	New engines even after they are lubricated may take a little bit to get everything run in. Be a little patient and let it run for a bit. It should clear up <b>shortly after lubricating and running</b>
	Check to see if you have any kind of binding on the side rods. There may be a chunk of your favorite, perfectly scaled pine tree stuck in there.
<b>PFA</b>	<b>Solution</b>
I hit F4 to start PFA but the engine just keeps ringing its bell, that's all it'll do	Bring the engine speed to 0. You will now hear the station arrival sounds (pretty cool, huh?). Pressing F4 will cycle you through the PFA sequence (check out the PFA section of the manual for more)
Why does my engine run away all by itself after the PFA is over?	This is normal. The engine will leave the station at the same speed it entered (when you hit F4 the first time). You can not control the speed of your engine while it's leaving the station, until the bell stops ringing.
<b>Shut Down</b>	<b>Solution</b>
Okay, I give up. What do I have to do to shut it down?	Well, you can either remove power from the track or press F3 again

## DCS (Remember, it's NOT DCC)

<b>Start-up</b>	<b>Solution</b>
When I apply power to the track my engine doesn't do anything. No lights, no sound, no nothing.	This is normal. You have to hit the Start-Up button.
	Check to see if that section of track has power. Use a voltmeter or a lit passenger car, not your tongue.
	Slide the engine a couple of feet in either direction, you may have a bad track section
	Have you got that section electrically isolated with a toggle switch or other device?
I get an error when I hit Start-Up	Have you recently changed the engine address?
	Check if there is power on that section of track the engine is sitting on (there has to be power for the signal to get to the engine and for the engine to be able to hear it)
	If you have two engines on the track they both may have the same address. Take one of them off the rails and try it again
<b>Sound</b>	<b>Solution</b>
When I press the Whistle Button on my DCS remote or DCS commander the whistle doesn't blow	Check if the playable whistle is active. On the DCS Commander there will be two dashes on the right side of the LCD if it's active. Press "A1" twice to ensure it's turned off. On your DCS remote press the "SPW" button twice to ensure it's disabled
I have no sound on my engine, but my lights are on and it moves just fine	You may have it turned off. Repeatedly press VOL + to bring the Master Volume up
	Did you turn off the ENG Sounds? Press the ENG SND button on your DCS controller.
	Check that you haven't lowered any of the independent engine volumes (Eng Sounds, Bell, Whistle, or Accent)
There's a crackling sound from my tender	Check to see if a screw or some other material hasn't lodged itself in the underside of the tender.
When I run Doppler I can hear the Doppler shift but then the engine sounds fade out and I can't get them back	This is normal. You will need to press the Doppler button again to turn Doppler off. Your engine sounds will now return to normal

<b>Smoke</b>	<b>Solution</b>
My engine isn't smoking at all	Press the smoke button this will activate the smoke
	If you just filled it with smoke fluid sometimes the fluid can make a seal in the stack. Blow down the stack to clear the air bubble
	Check the Tender/Boiler drawbar connection. You've got to have them locked together
My engine barely smokes	You may have set the smoke to Low. This can be changed from Low to Med to High
	Add 10-12 drops of smoke fluid.
	Check for an obstruction in the smoke stack
<b>Lights</b>	<b>Solution</b>
One of my lights is out	Check that you haven't turned it off with the DCS controller. You have independent control over lights on your engine
None of my lights are on	Could be the same reason as "One of my lights is out"
	Is the engine getting power? Check to see if there is voltage on the track or move the engine a few feet in either direction.
	Check the Tender/Boiler drawbar connection. You've got to have them locked together.
<b>Motion</b>	<b>Solution</b>
When I apply power and hit Start-Up my engine powers up but it won't move	Check the Tender/Boiler drawbar connection. You've got to have them locked together.
My engine hesitates at slow speeds	An engine may do this right out of the box if it has not been lubricated. Follow the lubrication instructions. Now go ahead and run it.
	New engines even after they are lubricated may take a little bit to get everything run in. Be a little patient and let it run for a bit. It should clear up shortly after lubricating and running
	Check to see if you have any kind of binding on the side rods. There may be a chunk of your favorite, perfectly scaled pine tree stuck in there.
<b>PFA</b>	<b>Solution</b>
When I enter PFA all that happens is the bell rings. What do I do?	Press the DIR button. Your engine will stop and begins the arrival sequence. Pressing the DIR button will cycle you through the next 3 PFA sequences
Why does my engine run away all by itself after the PFA is over?	This is normal. The engine will leave the station at the same speed it entered (when hit the PFA button). The speed setting can be changed after the bell stops ringing.
<b>Shut Down</b>	<b>Solution</b>
Okay, I give up. What do I have to do to shut it down?	Well, you can either remove power from the track or press or press Shut-Down. Button on the DCS Remote

# Service & Warranty Information

## How to Get Service Under the Terms of the Limited One-Year Warranty

When you suspect an item is defective, please check the operator's manual for standard operation and troubleshooting techniques that may correct the problem. Additional information may be found on the M.T.H. Website. Should you still require service, follow the instructions below to obtain warranty service.

First, e-mail, write, call or fax M.T.H. Electric Trains or a M.T.H. Authorized Service Center (ASC) in your area to obtain Repair Authorization. You can find the list of ASCs on the M.T.H. Website, [www.mth-railking.com](http://www.mth-railking.com). Authorized Service Centers are required to make warranty repairs on items sold *only* from that store; all other repairs may-- or may not be done at the store's own discretion. If you did not purchase the item directly from the ASC, you will need to select a National Authorized Service Center (NASC) or contact M.T.H. Electric Trains directly. NASC Dealers are compensated by M.T.H. to perform warranty service for any customer whose repair qualifies for warranty service. A list of NASC retailers can be located on the M.T.H. Website or by calling 410-381-2580. Should the warranty no longer apply, you may choose either an ASC or NASC retailer to service your M.T.H. Product. A reasonable service fee will be charged.

**CAUTION:** Make sure the product is packed in its original factory packaging including its foam and plastic wrapping material to prevent damage to the merchandise. There is no need to return the entire set if only one of the components is in need of repair *unless otherwise instructed by the Service Center*. **The shipment must be prepaid and we recommend that it be insured. A cover letter including your name, address, daytime phone number, e-mail address (if available), Return Authorization number (if required by the service center, a copy of your sales receipt and a full description of the problem must be included to facilitate the repairs. Please include the description regardless of whether you discussed the problem with a service technician when contacting the Service Center for your Return Authorization.**

Please make sure you have followed the instructions carefully before returning any merchandise for service. Authorized M.T.H. Service Centers are independently owned and operated and are not agents or representatives of M.T.H. Electric Trains. M.T.H. assumes no responsibility, financial or otherwise, for material left in their possession, or work done, by privately owned M.T.H. Authorized Service Centers. If you need assistance at any time email MTH Service at [service@mth-railking.com](mailto:service@mth-railking.com), or call 410 381-2580.

## Limited One-Year Warranty

All M.T.H. products purchased from an Authorized M.T.H. Retailer are covered by this warranty. See our Website to identify an Authorized M.T.H. Retailer near you.

M.T.H. products are warranted for one year from the date of purchase against defects in material or workmanship, excluding wear items such as light bulbs, pick-up rollers, batteries, smoke unit wicks, and traction tires. We will replace or credit (at our option) any defective item with a manufactured suggested retail price of \$279.95 or less (excluding all motive power and electronic items), if the item is returned to an M.T.H. Authorized Service Center (ASC) or M.T.H. National Authorized Service Center (NASC) within one year of the original date of purchase. For any item with an MSRP greater than \$279.95 (including all motive power and electronics), We will repair, replace or credit (at our option) the defective item without charge for the parts or labor, if the item is returned to an M.T.H. Authorized Service Center (ASC) or M.T.H. National Authorized Service Center (NASC) within one year of the original date of purchase. This warranty does not cover damages caused by improper care, handling, or use. Transportation costs incurred by the customer to ship the product for warranty service are not covered under this warranty.

Items sent for repair must be accompanied by a return authorization number, a description of the problem, and a copy of the original sales receipt from an Authorized M.T.H. Retailer stating the date of purchase. If you are sending this product to an Authorized Service Center, contact that Center for their return authorization.

This warranty gives you specific legal rights, and you may have other rights that vary from state to state. Specific questions regarding the warranty may be forwarded to M.T.H. directly

Service Department  
M.T.H. Electric Trains  
7020 Columbia Gateway Drive  
Columbia MD 21046-1532  
410-381-2580  
[service@mth-railking.com](mailto:service@mth-railking.com)